

ISOCOM[®]

L I M I T E D

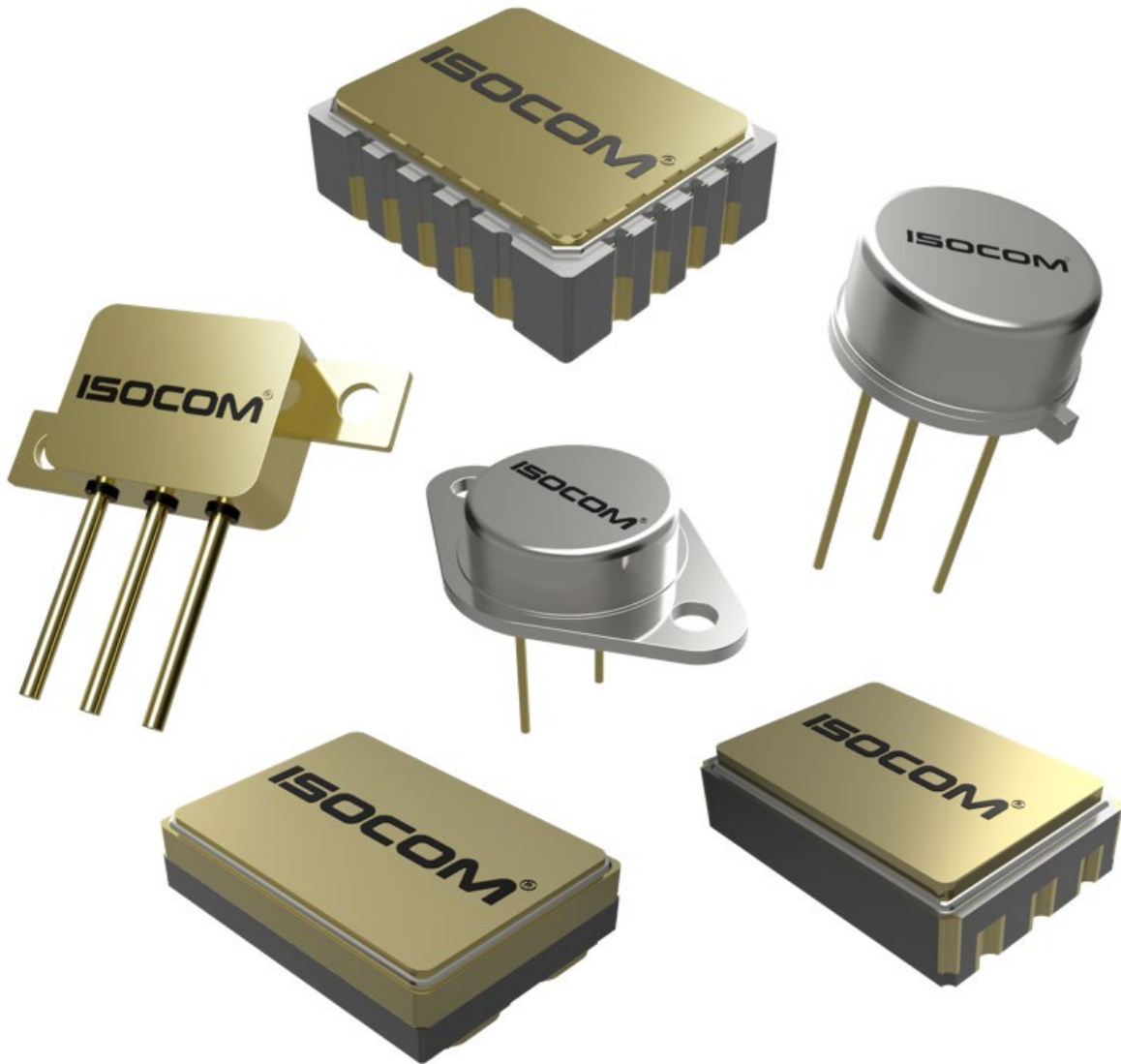

MOSFET SELECTION GUIDE

ISOCOM LIMITED FACILITIES AND CAPABILITIES

ISOCOM Limited is an AS9100D and ISO9001:2015 certified company based in the North East of England. We specialise in Custom Packaging, Hybrid Assembly Design, and offer clean room manufacturing, including wire bonding, die attaching and lid sealing. Our screening facilities and test capabilities include:

- ATE and bench test equipment for all component parameters
- High temperature handlers
- High/Low temperature forcing
- Die wafer probing
- High magnification inspection stations
- Acceleration tests to 5,000G
- Vibration test to MIL and DESC levels
- Solderability tests
- Fluorocarbon pressurisation and gross and fine leak tests
- Endurance tests and environmental tests, including temperature cycling and various burn-in processes
- Particle Impact Noise Detector (PIND) testing
- Hermetic Sealing of components
- Full production equipment for Hybrid and PCB assemblies
- Conceptual design to final production: components and systems
- Ceramic and metal product design



PART SCREENING OPTIONS

All products available in military (L2) and space grade (L2S) that can be screened to MIL-PRF-38534, applying test methods from MIL-STD-883; MIL-PRF-19500, applying test methods of MIL-STD-750; or a combination thereof. Please contact us for more information relating to the grading and applicable screening processes.

PRODUCT INDEX

MOSFET N-CHANNEL

20V - 30V	4
-----------	---

60V	5
-----	---

100V	7
------	---

200V	10
------	----

400V	11
------	----

500V - 550V	12
-------------	----

600V - 650V	13
-------------	----

800V	14
------	----

MOSFET P-CHANNEL

60V	6
-----	---

100V	9
------	---

MOSFET DUAL-CHANNEL (N and P)



60V	14
-----	----

ISOCOM PACKAGE DRAWINGS	15
--------------------------------	----

ISOCOM PART NUMBER DEFINITIONS	20
---------------------------------------	----

SCREENING PROCESS FLOW	21
-------------------------------	----

20V N-Channel MOSFET

Part No.	BV_{DSS} max(V)	I_D max(A)	$R_{DS(on)}$ max(Ω)	I_{DSS} max(μ A)	$V_{GS(th)}$ max(V)	Package
ISM02NSM-12	20	12.00	0.045	1.0	1.0	SMD 0.2 
ISM02NT0-12	20	12.00	0.045	1.0	1.0	TO-39 

30V N-Channel MOSFET

Part No.	BV_{DSS} max(V)	I_D max(A)	$R_{DS(on)}$ max(Ω)	I_{DSS} max(μ A)	$V_{GS(th)}$ max(V)	Package
ISM03NL1-12	30	12.00	0.0700	10.0	4.0	LCC 18 
ISM03NS0-22	30	22.00	0.0200	10.0	4.0	SMD 0.5 
ISM03NT2-12	30	12.00	0.0450	10.0	4.0	TO-205AF 
ISM03NT3-35	30	35.00	0.0140	25.0	4.0	TO-254AA 
ISM03NT3-45	30	45.00	0.0055	10.0	4.0	TO-254AA 
ISM03NT4-18	30	18.00	0.0300	10.0	4.0	TO-257AA 

All products available in Military grade and Space grade options. Please contact us for more information

60V N-Channel MOSFET

Part No.	V_{DSS} max(V)	I_D max(A)	$R_{DS(on)}$ max(Ω)	I_{DSS} max(μ A)	$V_{GS(th)}$ max(V)	Package	
ISM06NL1-12	60	11.70	0.080	10.0	4.0	LCC 18	
ISM06NS0-14	60	14.0	0.115	1.0	1.5	SMD 0.5	
ISM06NS0-22	60	22.00	0.039	1.0	2.0	SMD 0.5	
ISM06NS0-30	60	30.0	0.020	1.0	2.5	SMD 0.5	
ISM06NS0-40	60	40.0	0.012	1.0	2.5	SMD 0.5	
ISM06NS1-35	60	35.00	0.030	25.0	4.0	SMD 1.0	
ISM06NT1-45	60	45.00	0.028	25.0	4.0	TO-204AE	
ISM06NT2-2	60	1.60	0.650	1.0	2.0	TO-205AF	
ISM06NT2-12	60	12.00	0.048	10.0	4.0	TO-205AF	
ISM06NT2-30	60	30.00	0.045	1.0	2.0	TO-205AF	
ISM06NT3-35	60	35.00	0.012	25.0	4.0	TO-254AA	
ISM06NT4-18	60	18.00	0.040	10.0	4.0	TO-257AA	
ISM06NT4-20	60	20.00	0.045	1.0	2.0	TO-257AA	
ISM06NT4-30	60	30.00	0.045	1.0	2.0	TO-257AA	

All products available in Military grade and Space grade options. Please contact us for more information

60V N-Channel MOSFET











Part No.	BV_{DSS} max(V)	I_D max(A)	$R_{DS(on)}$ max(Ω)	I_{DSS} max(μ A)	$V_{GS(th)}$ max(V)	Package
ISM06NUB-14	60	14.00	0.115	1.0	2.5	UBN

60V P-Channel MOSFET

Part No.	BV_{DSS} max(V)	I_D max(A)	$R_{DS(on)}$ max(Ω)	I_{DSS} max(μ A)	$V_{GS(th)}$ max(V)	Package
ISM06PS0-5	-60	-5.00	0.160	-1.0	-3.0	SMD 0.5
ISM06PS0-21	-60	-21.00	0.085	-10.0	-4.0	SMD 0.5
ISM06PS0-22	-60	-22.00	0.072	-1.0	-2.0	SMD 0.5
ISM06PS1-35	-60	-35.00	0.035	-1.0	-2.5	SMD 1.0
ISM06PS2-35	-60	-35.00	0.025	-25.0	-2.5	SMD 2.0
ISM06PT3-35	-60	-35.00	0.050	-25.0	-4.0	TO-254AA
ISM06PT4-18	-60	-18.00	0.095	-10.0	-4.0	TO-257AA
ISM06PT4-20	-60	-20.00	0.087	-10.0	-4.0	TO-257AA
ISM06PUB-1	-60	-0.53	1.400	-1.0	-2.0	UBN









All products available in Military grade and Space grade options. Please contact us for more information

100V N-Channel MOSFET

Part No.	V_{DSS} max(V)	I_D max(A)	$R_{DS(on)}$ max(Ω)	I_{DSS} max(μ A)	$V_{GS(th)}$ max(V)	Package	
ISM10NL1-4	100	3.5	0.690	25.0	4.0	LCC 18	
ISM10NS0-15	100	14.4	0.200	25.0	4.0	SMD 0.5	
ISM10NS0-22	100	22.0	0.420	10.0	4.0	SMD 0.5	
ISM10NS1-14	100	14.0	0.200	25.0	4.0	SMD 1.0	
ISM10NS1-34	100	34.0	0.076	25.0	4.0	SMD 1.0	
ISM10NS2-51	100	51.0	0.045	25.0	4.0	SMD 2.0	
ISM10NSM-7	100	6.5	0.290	1.0	2.0	SMD 0.2	
ISM10NT1-34	100	34.00	0.076	25.0	4.0	TO-204AE	
ISM10NT2-4	100	3.50	0.690	25.0	4.0	TO-205AF	
ISM10NT2-6	100	6.00	0.320	1.0	2.0	TO-205AF	
ISM10NT2-8	100	8.00	0.185	25.0	4.0	TO-205AF	
ISM10NT2-12	100	11.70	0.080	10.0	4.0	TO-205AF	
ISM10NT3-14	100	14.00	0.200	25.0	4.0	TO-254AA	
ISM10NT3-34	100	34.00	0.076	25.0	4.0	TO-254AA	







All products available in Military grade and Space grade options. Please contact us for more information

100V N-Channel MOSFET

Part No.	BV _{DSS} max(V)	I _D max(A)	R _{Ds(on)} max(Ω)	I _{DSS} max(μA)	V _{GS(th)} max(V)	Package	
ISM10NT3-35	100	35.00	0.018	25.0	4.0	TO-254AA	
ISM10NT3-45	100	45.00	0.011	10.0	4.0	TO-254AA	
ISM10NT4-15	100	14.40	0.200	10.0	4.0	TO-257AA	
ISM10NT4-16	100	16.00	0.077	25.0	4.0	TO-257AA	
ISM10NT4-18	100	18.00	0.070	10.0	4.0	TO-257AA	
ISM10NT4-20	100	20.00	0.070	10.0	4.0	TO-257AA	
ISM10NT4-22	100	22.00	0.050	10.0	2.5	TO-257AA	
ISM10NT6-14	100	14.0	0.200	25.0	4.0	TO-204AA	
ISM10NUB-3	100	3.0	0.310	1.0	2.5	UBN	











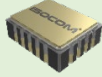





All products available in Military grade and Space grade options. Please contact us for more information

100V P-Channel MOSFET

Part No.	BV_{DSS} max(V)	I_D max(A)	$R_{DS(on)}$ max(Ω)	I_{DSS} max(μ A)	$V_{GS(th)}$ max(V)	Package
ISM10PT2-7	-100	-6.5	0.350	-25.0	-4.0	TO-205AF 
ISM10PT4-16	-100	-16.0	0.200	-25.0	-2.5	TO-257AA 
ISM10PT4-19	-100	-19.0	0.045	-1.0	-2.5	TO-257AA 
ISM10PT4-30	-100	-30.0	0.045	-1.0	-2.5	TO-257AA 
ISM10PT4-45	-100	-45.0	0.050	-10.0	-4.0	TO-257AA 
ISM10PS0-12	-100	-12.0	0.045	-10.0	-2.5	SMD 0.5 
ISM10PS2-30	-100	-30.0	0.045	-1.0	-2.5	SMD 2.0 





All products available in Military grade and Space grade options. Please contact us for more information

200V N-Channel MOSFET





Part No.	BV _{DSS} max(V)	I _D max(A)	R _{DS(on)} max(Ω)	I _{DSS} max(μA)	V _{GS(th)} max(V)	Package	
ISM20NL1-6	200	5.5	0.350	25.0	4.0	LCC 18	
ISM20NL1-8	200	8.0	0.175	10.0	4.0	LCC 18	
ISM20NS0-10	200	9.4	0.400	25.0	4.0	SMD 0.5	
ISM20NS0-12	200	12.0	0.220	10.0	4.5	SMD 0.5	
ISM20NS0-16	200	16.0	0.130	10.0	4.0	SMD 0.5	
ISM20NS1-9	200	9.0	0.400	25.0	4.0	SMD 1.0	
ISM20NS1-26	200	26.0	0.100	25.0	4.5	SMD 1.0	
ISM20NS1-31	200	31.0	0.060	10.0	4.5	SMD 1.0	
ISM20NS2-43	200	43.0	0.070	25.0	4.0	SMD 2.0	
ISM20NT1-9	200	9.0	0.400	25.0	4.0	TO-204AE	
ISM20NT1-26	200	26.0	0.110	25.0	4.0	TO-204AE	
ISM20NT2-6	200	5.5	0.350	25.0	4.0	TO-205AF	
ISM20NT2-7	200	7.0	0.240	10.0	4.5	TO-205AF	
ISM20NT2-8	200	7.3	0.220	25.0	4.0	TO-205AF	
ISM20NT2-10	200	9.1	0.145	10.0	4.0	TO-205AF	
ISM20NT3-9	200	9.0	0.400	25.0	4.0	TO-254AA	
ISM20NT3-26	200	26.0	0.100	25.0	4.0	TO-254AA	

All products available in Military grade and Space grade options. Please contact us for more information

200V N-Channel MOSFET











Part No.	BV _{DSS} max(V)	I _D max(A)	R _{DS(on)} max(Ω)	I _{DSS} max(μA)	V _{GS(th)} max(V)	Package
ISM20NT3-35	200	35.0	0.077	25.0	4.0	TO-254AA 
ISM20NT3-45	200	45.0	0.044	10.0	4.5	TO-254AA 
ISM20NT4-10	200	9.4	0.400	25.0	4.0	TO-257AA 
ISM20NT4-12	200	12.0	0.230	10.0	4.5	TO-257AA 
ISM20NT4-16	200	16.0	0.130	10.0	4.0	TO-257AA 

400V N-Channel MOSFET

Part No.	BV _{DSS} max(V)	I _D max(A)	R _{DS(on)} max(Ω)	I _{DSS} max(μA)	V _{GS(th)} max(V)	Package
ISM40NS0-6	400	5.3	1.2	50.0	4.5	SMD 0.5 
ISM40NS2-24	400	24.0	0.2	50.0	4.5	SMD 2.0 
ISM40NT2-3	400	3.0	1.2	50.0	4.5	TO-205AF 
ISM40NT3-22	400	22.0	0.2	50.0	4.5	TO-254AA 

All products available in Military grade and Space grade options. Please contact us for more information

500V N-Channel MOSFET



Part No.	BV_{DSS} max(V)	I_D max(A)	$R_{DS(on)}$ max(Ω)	I_{DSS} max(μ A)	$V_{GS(th)}$ max(V)	Package	
ISM50NS0-5	500	12.0	0.51	50.0	4.5	SMD 1.0	
ISM50NS0-12	500	20.0	0.32	50.0	4.5	SMD 0.5	
ISM50NS0-20	500	4.5	1.60	50.0	4.5	SMD 0.5	
ISM50NS1-11	500	18.0	0.32	50.0	4.5	SMD 1.0	
ISM50NT1-11	500	12.0	0.51	50.0	4.5	TO-204AE	
ISM50NT1-12	500	20.0	0.32	50.0	4.0	TO-204AE	
ISM50NT2-3	500	20.0	0.32	50.0	4.5	TO-205AF	
ISM50NT3-11	500	11.0	0.45	50.0	4.5	TO-254AA	
ISM50NT3-12	500	12.0	0.51	50.0	4.5	TO-254AA	
ISM50NT3-18	500	2.6	1.65	50.0	4.5	TO-254AA	
ISM50NT5-20	500	11.0	0.45	50.0	4.5	TO-259AA	

550V N-Channel MOSFET



Part No.	BV_{DSS} max(V)	I_D max(A)	$R_{DS(on)}$ max(Ω)	I_{DSS} max(μ A)	$V_{GS(th)}$ max(V)	Package	
ISM55NS0-4	550	3.4	2.90	10.0	4.0	SMD 0.5	

All products available in Military grade and Space grade options. Please contact us for more information

600V N-Channel MOSFET

Part No.	BV _{DSS} max(V)	I _D max(A)	R _{DS(on)} max(Ω)	I _{DSS} max(μA)	V _{GS(th)} max(V)	Package
ISM60NS0-4	600	3.4	2.9	10.0	4.0	SMD 0.5 
ISM60NT4-4	600	3.4	3.0	10.0	4.0	TO-257AA 

620V N-Channel MOSFET

Part No.	BV _{DSS} max(V)	I _D max(A)	R _{DS(on)} max(Ω)	I _{DSS} max(μA)	V _{GS(th)} max(V)	Package
ISM62NS1-1	620	0.6	23.0	10.0	3.0	SMD 1.0 
ISM62NS2-2	620	1.8	6.5	10.0	3.0	SMD 1.0 

620V N-Channel MOSFET's also available in SMD 0.5 and TO-257AA package. Please contact us for more information

650V N-Channel MOSFET's also available in SMD 0.5 and SMD 1.0 package. Please contact us for more information

650V N-Channel MOSFET

Part No.	BV _{DSS} max(V)	I _D max(A)	R _{DS(on)} max(Ω)	I _{DSS} max(μA)	V _{GS(th)} max(V)	Package
ISM65NT4-4	650	4.0	4.5	10.0	3.5	TO-257AA 

All products available in Military grade and Space grade options. Please contact us for more information

800V N-Channel MOSFET

Part No.	BV _{DSS} max(V)	I _D max(A)	R _{DS(on)} max(Ω)	I _{DSS} max(μA)	V _{GS(th)} max(V)	Package
ISM80NT1-20	800	20.0	0.430	100.0	3.5	TO-3 

60V Dual-Channel MOSFET

Part No.	Channel	BV _{DSS} max(V)	I _D max(A)	R _{DS(on)} max(Ω)	I _{DSS} max(μA)	V _{GS(th)} max(V)	Package
ISMD06CL0-1	N	60.0	0.89	0.750	1.0	2.0	LCC-6 
	P	-60.0	-0.65	1.600	-1.0	-2.0	

All products available in Military grade and Space grade options. Please contact us for more information

ISOCOM Package Drawings (mm)

LCC-6 (L0)

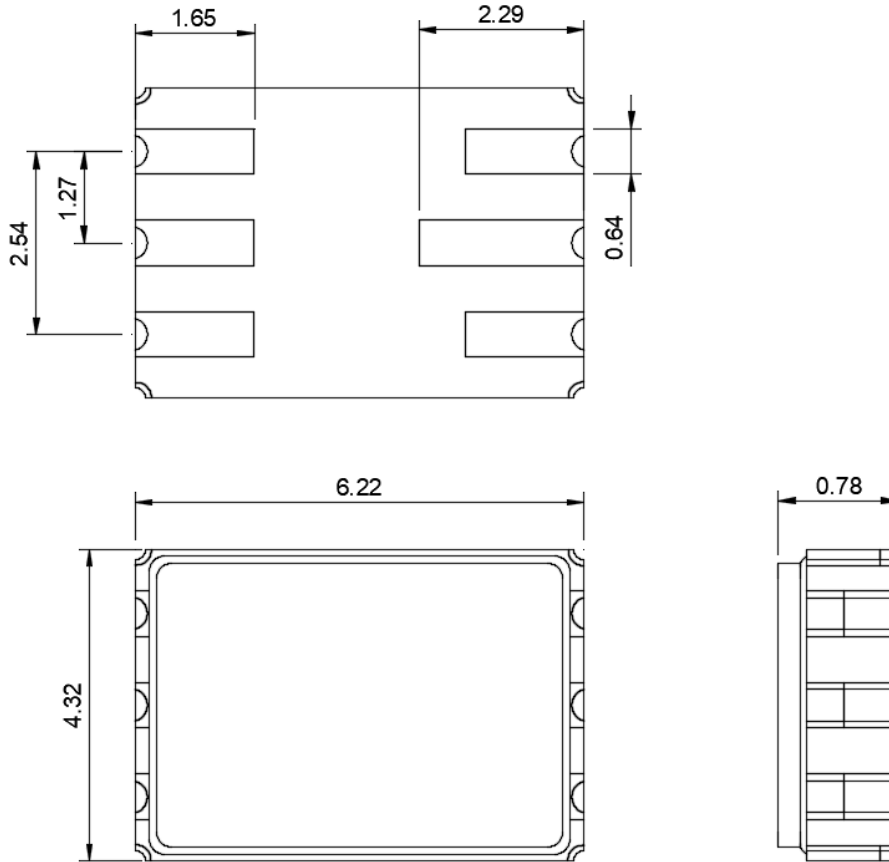

LCC-18 (L1)

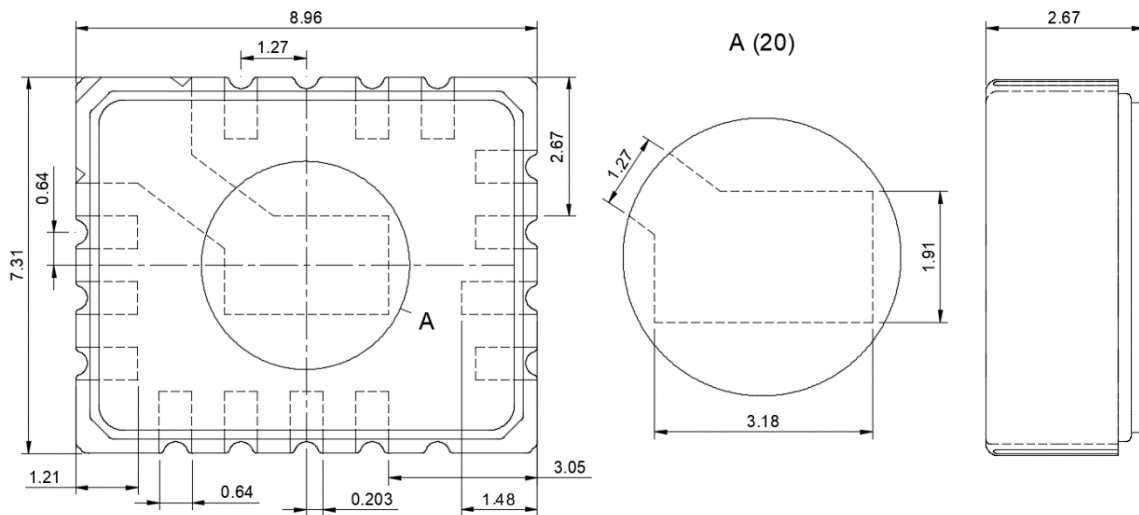

SMD 0.2 (SM)

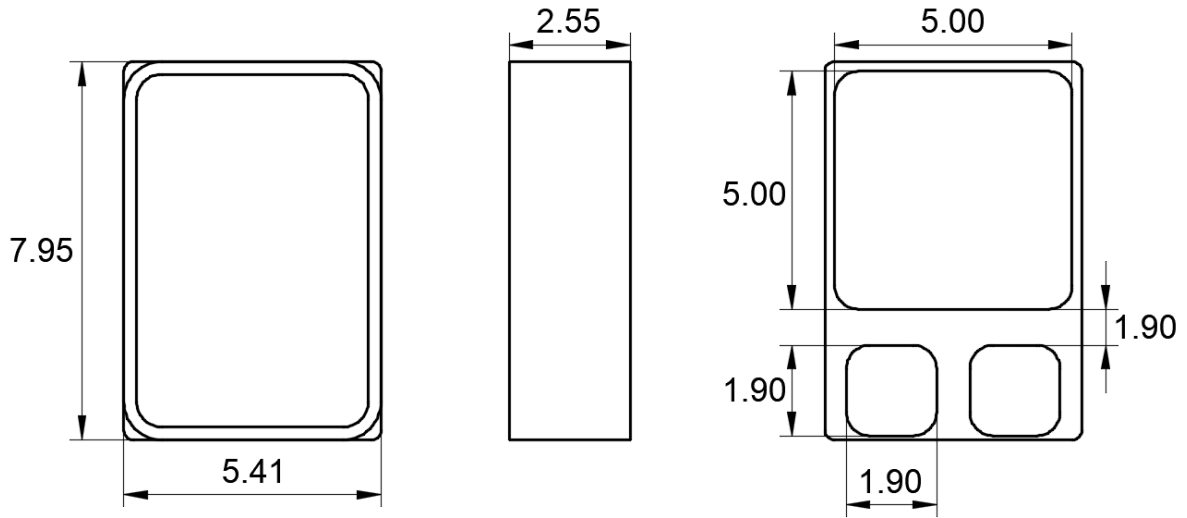

SMD 0.5 (S0)

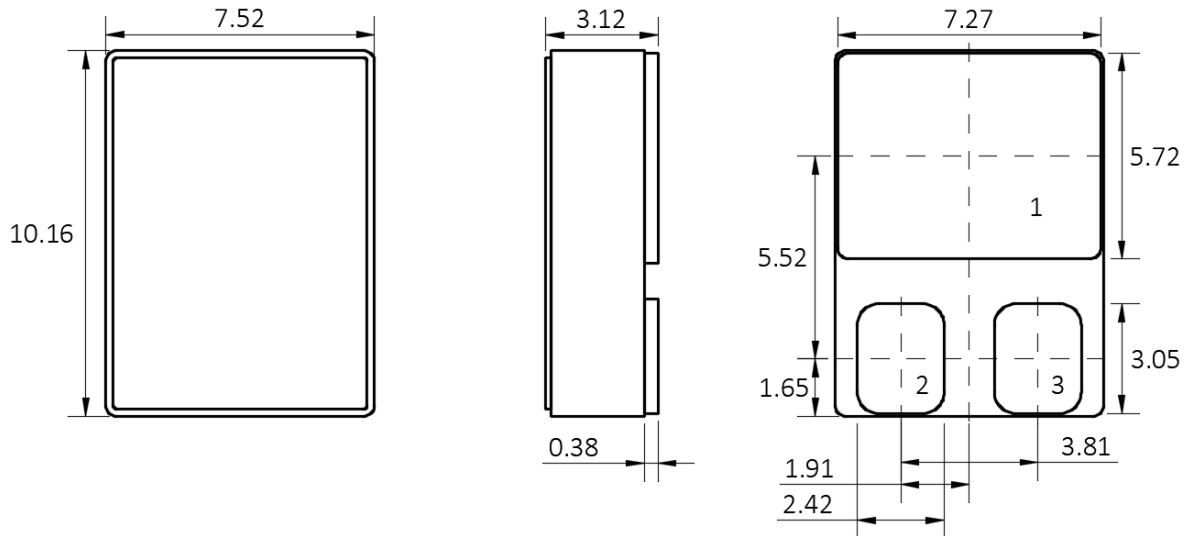

SMD 1.0 (S1)

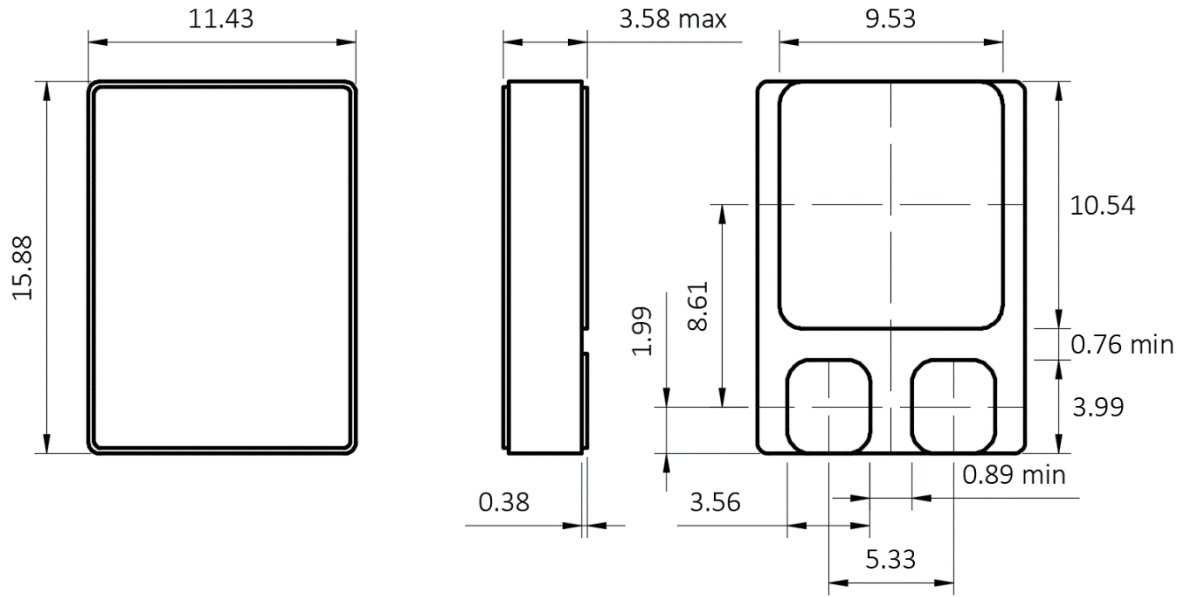

SMD 2.0 (S2)

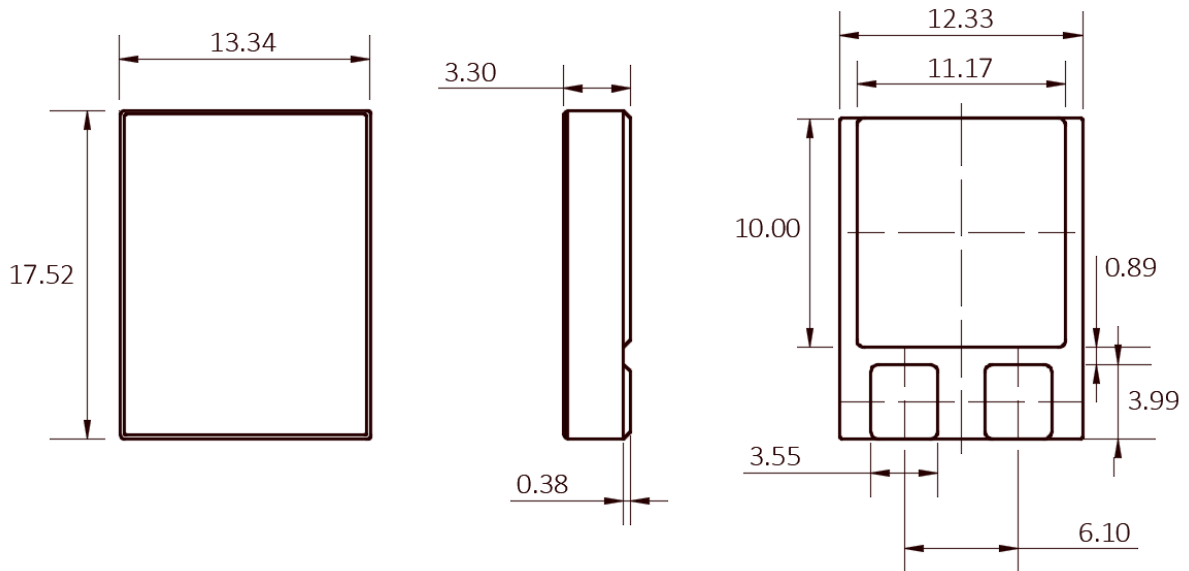

TO-39 (T0), TO-205AF (T2)

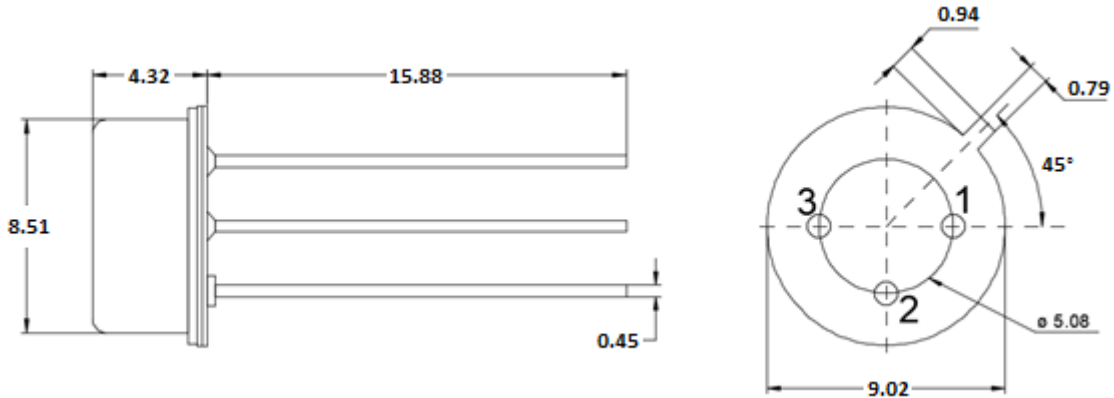

TO-204AE (T1), TO-204AA (T6), T0-3

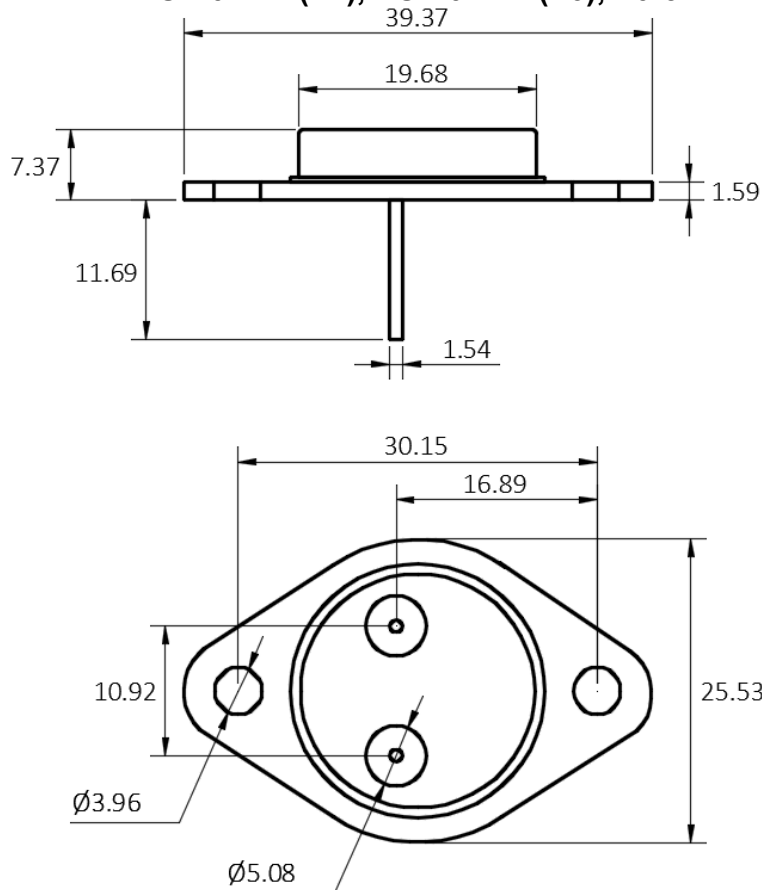

TO-254AA (T3)

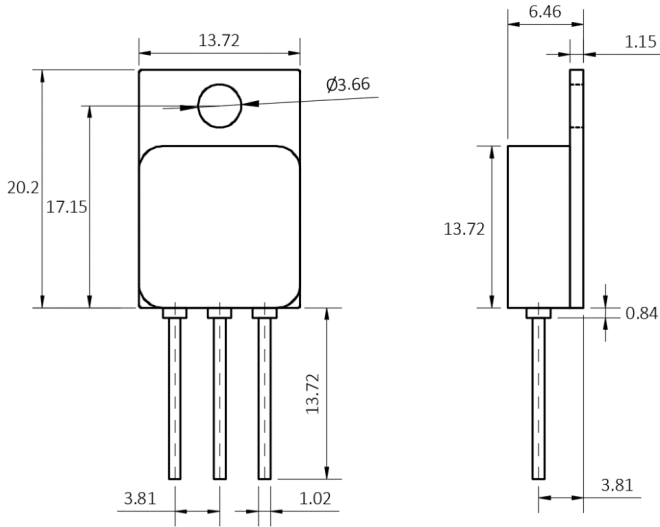

TO-257AA (T4)

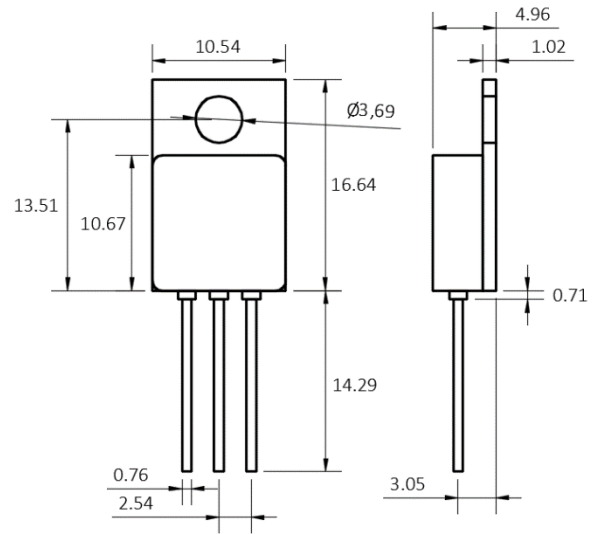

TO-259AA (T5)

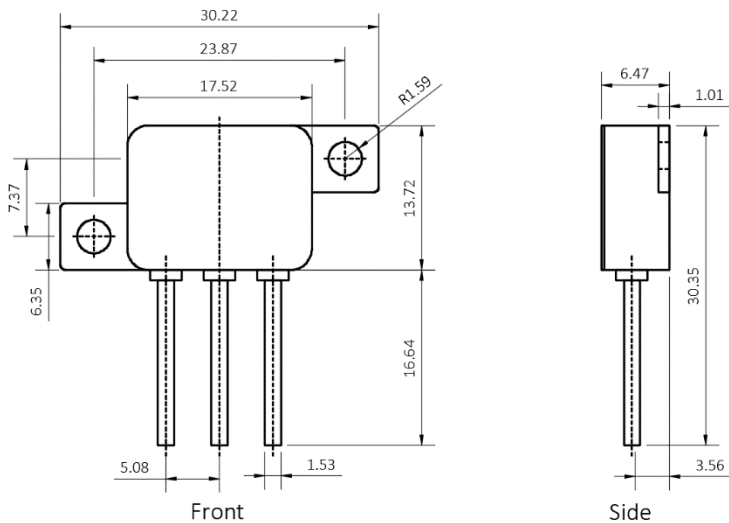

UBN (UB)

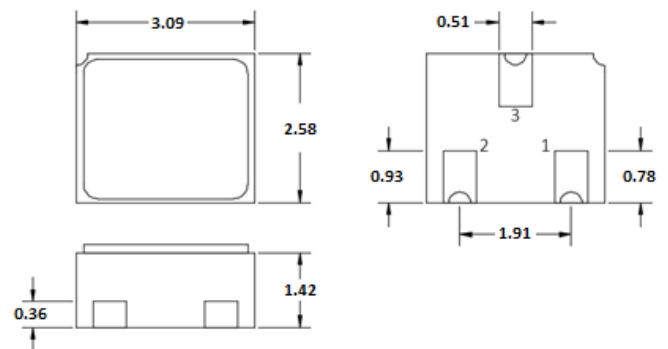

ISOCOM Part Number Definitions

ISM 60 N S1 - 4 /L2S

<u>Manufacturer</u>	<u>Voltage</u>	<u>Type of Channel</u>	<u>Package Designator</u>	<u>Amperage</u>	<u>Screening Level</u>
ISOCOM MOSFET	02 = 20V	N P	L0 = LCC 6	05 = 0.5A	Blank = Commercial /L2 = Military Defence/ Aerospace /L2S = Space
	03 = 30V		L1 = LCC 18	06 = 0.6A	
	06 = 60V		L2 = LCC 28	1 = 1.0A	
	10 = 100V		SM = SMD 0.2	S0 = SMD 0.5	2 = 2.0A
	20 = 200V		S1 = SMD 1.0	S2 = SMD 2.0	3 = 3.0A
	40 = 400V		T0 = TO-39	T1 = TO-204AE	4 = 4.0A
	50 = 500V		T2 = TO-205AF	T3 = TO-254AA	5 = 5.0A
	55 = 550V		T4 = TO-257AA	T5 = TO-259AA	6 = 6.0A
	60 = 600V		T6 = TO-204AA	UB = UBN	7 = 7.5A
	62 = 620V				9 = 9.0A
	65 = 650V				10 = 10A
	70 = 700V				11 = 11A
					12 = 12A
			14 = 14A		
			18 = 18A		
			22 = 22A		
			25 = 25A		
			30 = 30A		
			35 = 35A		
			51 = 51A		
			60 = 60A		
			65 = 65A		
			70 = 70A		
			80 = 80A		
			85 = 85A		

SCREENING PROCESS FLOW

MIL-PRF-19500 SCREENING FLOW OPTIONS

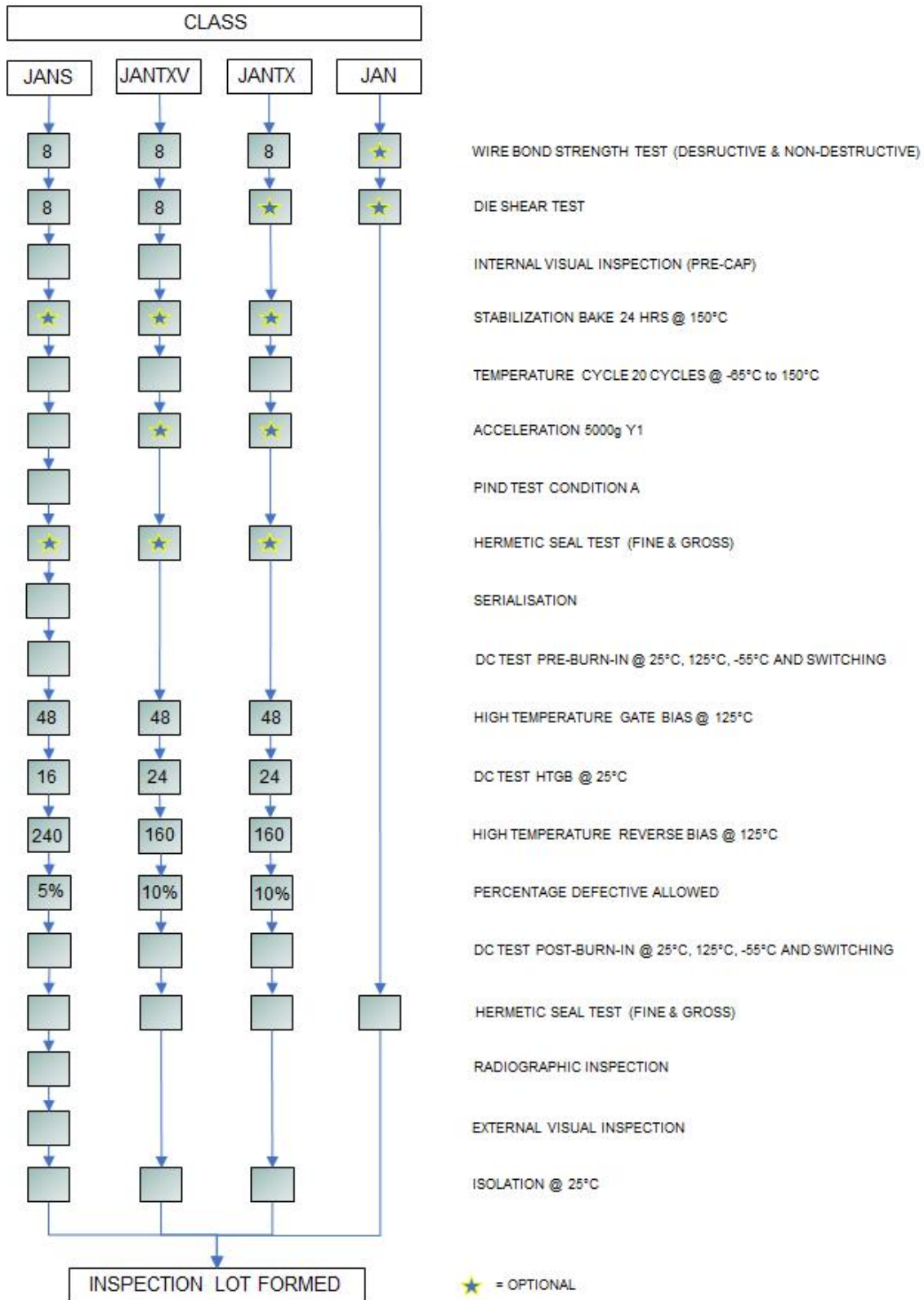

MIL-PRF-385334 SCREENING FLOW OPTIONS

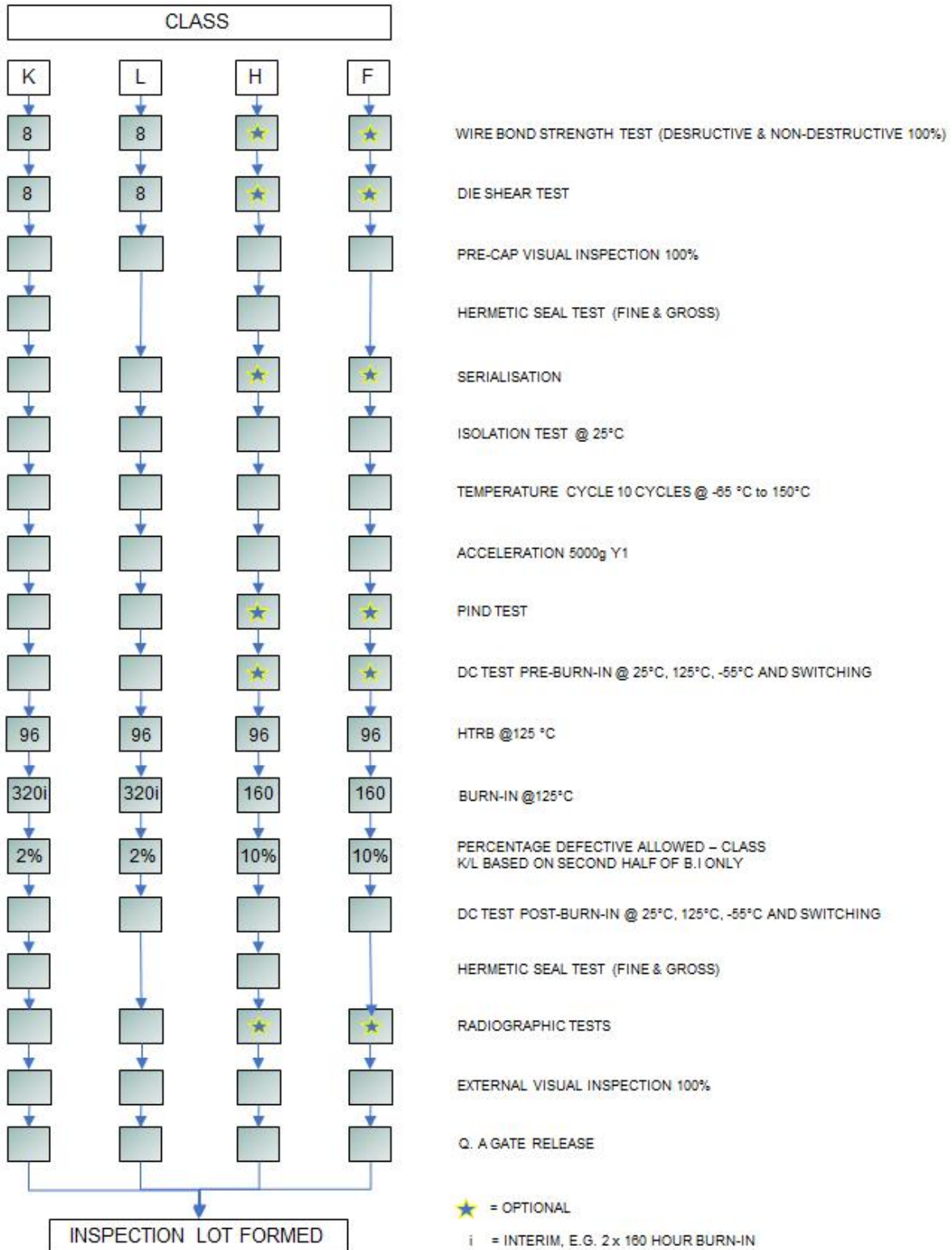



ISOCOM Limited
2 Fern Court
Bracken Hill Business Park
Peterlee
County Durham
SR8 2RR
United Kingdom

T: +44 (0)191 416 6546
E: sales@isocom.uk.com

www.isocom.uk.com